

NSK

CREATE IT.

Ti·Max Z

Contra-angle & Air Turbine

Z95L
Contra-angle



Z900L
Air Turbine

THE SINGULAR ESSENCE OF QUALITY

As specialists in ultra-high-speed rotary equipment, NSK is passionate about creating innovative products that deliver outstanding value. NSK manufactures almost all parts in-house to guarantee the highest precision, reliability and unmatched performance of all products. The Ti-Max Z contra-angle and air turbine series resulted from NSK's constant quest to make the impossible possible.

Ti-Max Z

INDEX

Contra-angle Series P 03-14

Air Turbine Series P 15-22

Ti·Max Z CONTRA-ANGLE

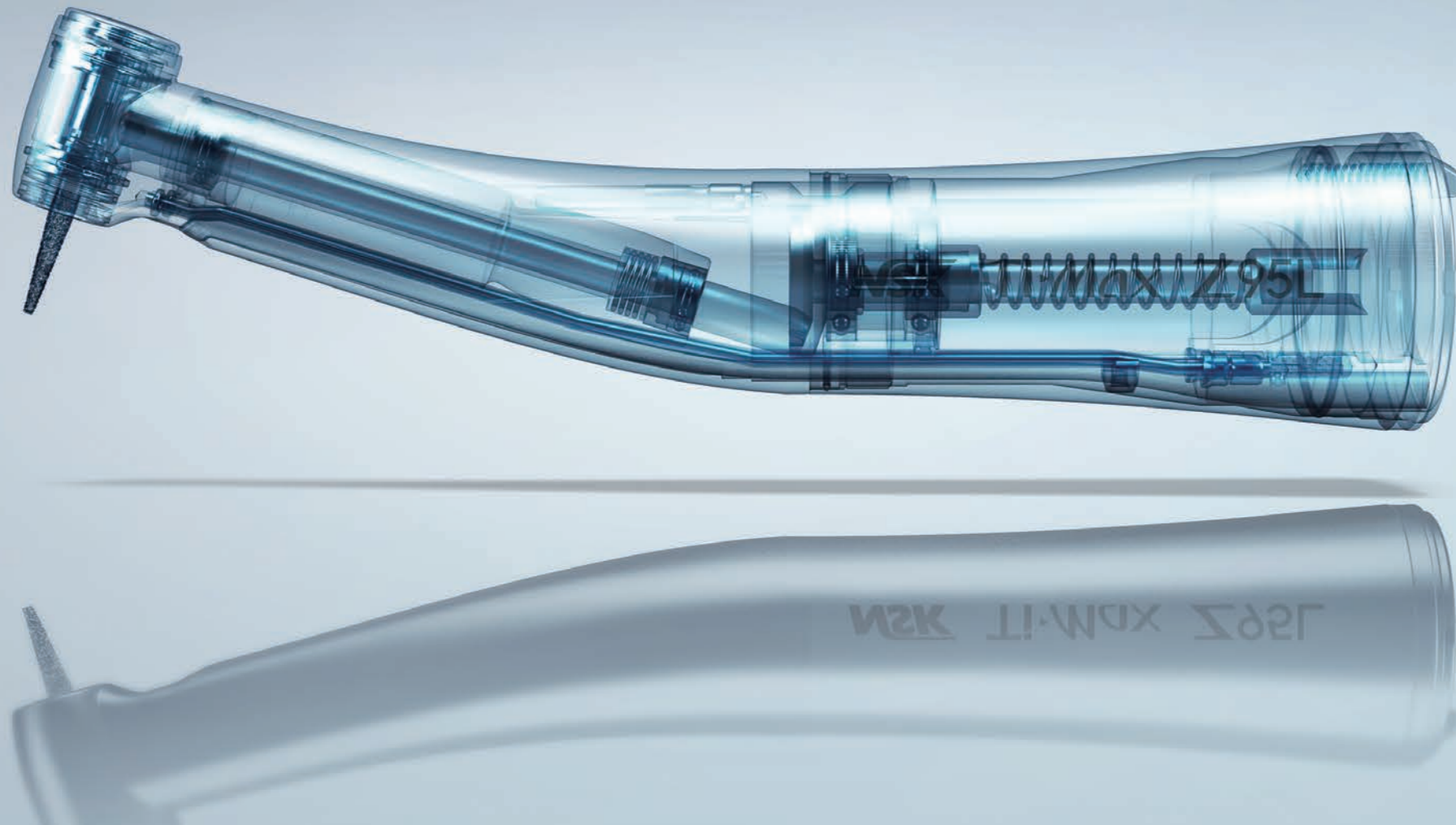

TECHNOLOGY & FUNCTION

Shorter Head and
Smaller Diameter

Slimmer Neck for Greater Visibility

Slimmer Lower Body Parts

Amazing Silence and
Minimal Vibration

Advanced Assembly Precision

Titanium Body

DURAGRIP

DLC Coating

Anti Heat System

Ceramic Bearing

Push Button Chuck

Quattro Water Spray

Microfilter

Clean Head System



DURABLE

A stunningly durable and reliable handpiece

NSK has combined advanced design and world-class processing technology to create incredibly durable instruments. The gear is coated with special diamond-like carbon to make wear resistance up to five times greater than on previous models. NSK's advanced technologies have boosted sterilization resistance, delivering even better reliability for dental practices.

COMFORT

The ultimate in handpieces

The result of invaluable clinical feedback

The handpiece is more user-friendly, cleaner, and safer. By reviewing everything from the shape of the instrument, to hygiene aspects and safety features using the most advanced technologies, we have made the contra-angle more ergonomic and comfortable for the clinician and safer for the patient, reducing stress for clinicians and patients alike. Only NSK's Ti-Max Z premium range offers these unique features.



ADVANCED TECHNOLOGY



Amazingly Silent Operation

Amazing silence and minimal vibration: The marriage of micro-precision parts and gears has lowered noise and vibration even more to provide comfort for clinicians and patients alike.

Anti Heat System (Z95L, Z85L, Z84L, Z45L)



Anti Heat System: Our proprietary Anti Heat System dramatically reduces the heat typically experienced with speed increasing contra-angles. This feature improves patient safety without compromising manoeuvrability.

OUTSTANDING OPERABILITY

Z95L

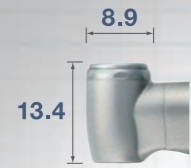

ACTUAL SIZE

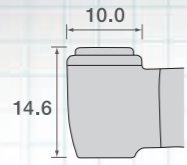

NSK X95L

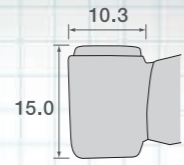

Competitor A

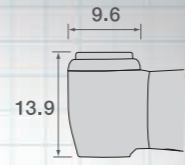

Competitor B

The Smallest Head

The head is angled 2° more than on the X95L for much better visibility and accessibility even for molars and other areas that are difficult to treat.



ACTUAL SIZE



The Slimmest Neck

The slimmer neck provides much better visibility compared to existing products, delivering wide visibility of all treatment areas.



ACTUAL SIZE

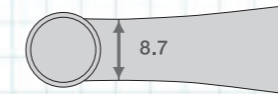

NSK X95L

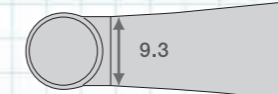

Competitor A

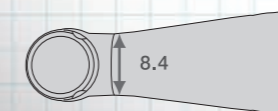

Competitor B

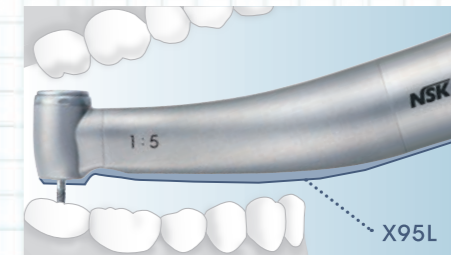

Easier Access

The slimmer handpiece body and neck enhances access to molars without touching anterior teeth.

Ti·Max Z CONTRA-ANGLE LINEUP



Gear Ratio 1:5 Increasing

OPTIC MODEL : Z95L ORDER CODE : C1034

- Max Speed : 200,000 min⁻¹ ● For FG burs (φ1.6) ● Head Size : φ8.9 × H13.4 mm ● Titanium Body & DURAGRIP ● DLC Coating ● Anti Heat System
- Ceramic Bearings ● Push Button Chuck ● Quattro Water Spray ● Microfilter ● Clean Head System ● Cellular Glass Optics



Gear Ratio 1:4.5 Increasing Mini Head

OPTIC MODEL : Z84L ORDER CODE : C1135

- Max Speed : 180,000 min⁻¹ ● For FG burs (φ1.6) * For Short Shank Bur ● Head Size : φ8.9 × H12.6 mm ● Titanium Body & DURAGRIP ● DLC Coating
- Anti Heat System ● Ceramic Bearings ● Push Button Chuck ● Quattro Water Spray ● Microfilter ● Clean Head System ● Cellular Glass Optics



Gear Ratio 1:5 Increasing Mini Head

OPTIC MODEL : Z85L ORDER CODE : C1062

- Max Speed : 200,000 min⁻¹ ● For FG burs (φ1.6) * For Short Shank Bur ● Head Size : φ8.9 × H11.8 mm ● Titanium Body & DURAGRIP ● DLC Coating
- Anti Heat System ● Ceramic Bearings ● Push Button Chuck ● Single Spray ● Microfilter ● Clean Head System ● Cellular Glass Optics



Gear Ratio 1:4.2 Increasing 45° Head

OPTIC MODEL : Z45L ORDER CODE : C1064

- Max Speed : 168,000 min⁻¹ ● For FG burs (φ1.6) ● Head Size : φ8.9 × H13.4 mm ● Titanium Body & DURAGRIP ● DLC Coating ● Anti Heat System
- Ceramic Bearings ● Push Button Chuck ● Quattro Water Spray (with two way spray function) ● Microfilter ● Clean Head System ● Cellular Glass Optics



Ti·Max Z CONTRA-ANGLE LINEUP



Gear Ratio 1:1 Direct Drive

OPTIC MODEL : Z25L ORDER CODE : C1038

- Max Speed : 40,000 min⁻¹ ● For CA burs (φ2.35) ● Head Size : φ8.9 × H13.7 mm ● Titanium Body & DURAGRIP
- Push Button Chuck ● Single Spray ● Microfilter ● Clean Head System ● Cellular Glass Optics



Gear Ratio 4:1 Reduction

OPTIC MODEL : Z15L ORDER CODE : C1039

- Max Speed : 10,000 min⁻¹ ● For CA burs (φ2.35) ● Head Size : φ8.9 × H13.4 mm ● Titanium Body & DURAGRIP
- Push Button Chuck ● Single Spray ● Microfilter ● Clean Head System ● Cellular Glass Optics



Gear Ratio 1:1 Direct Drive Mini Head

OPTIC MODEL : Z24L ORDER CODE : C1126

- Max Speed : 40,000 min⁻¹ ● For CA burs (φ2.35)* Max 22.5 mm ● Head Size : φ8.9 × H12.3 mm ● Titanium Body & DURAGRIP
- Push Button Chuck ● Single Spray ● Microfilter ● Cellular Glass Optics



Gear Ratio 16:1 Reduction

OPTIC MODEL : Z10L ORDER CODE : C1040

- Max Speed : 2,500 min⁻¹ ● For CA burs (φ2.35) ● Head Size : φ8.9 × H13.4 mm ● Titanium Body & DURAGRIP
- Push Button Chuck ● Single Spray ● Microfilter ● Clean Head System ● Cellular Glass Optics

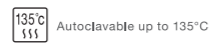

Ti·Max Z AIR TURBINE

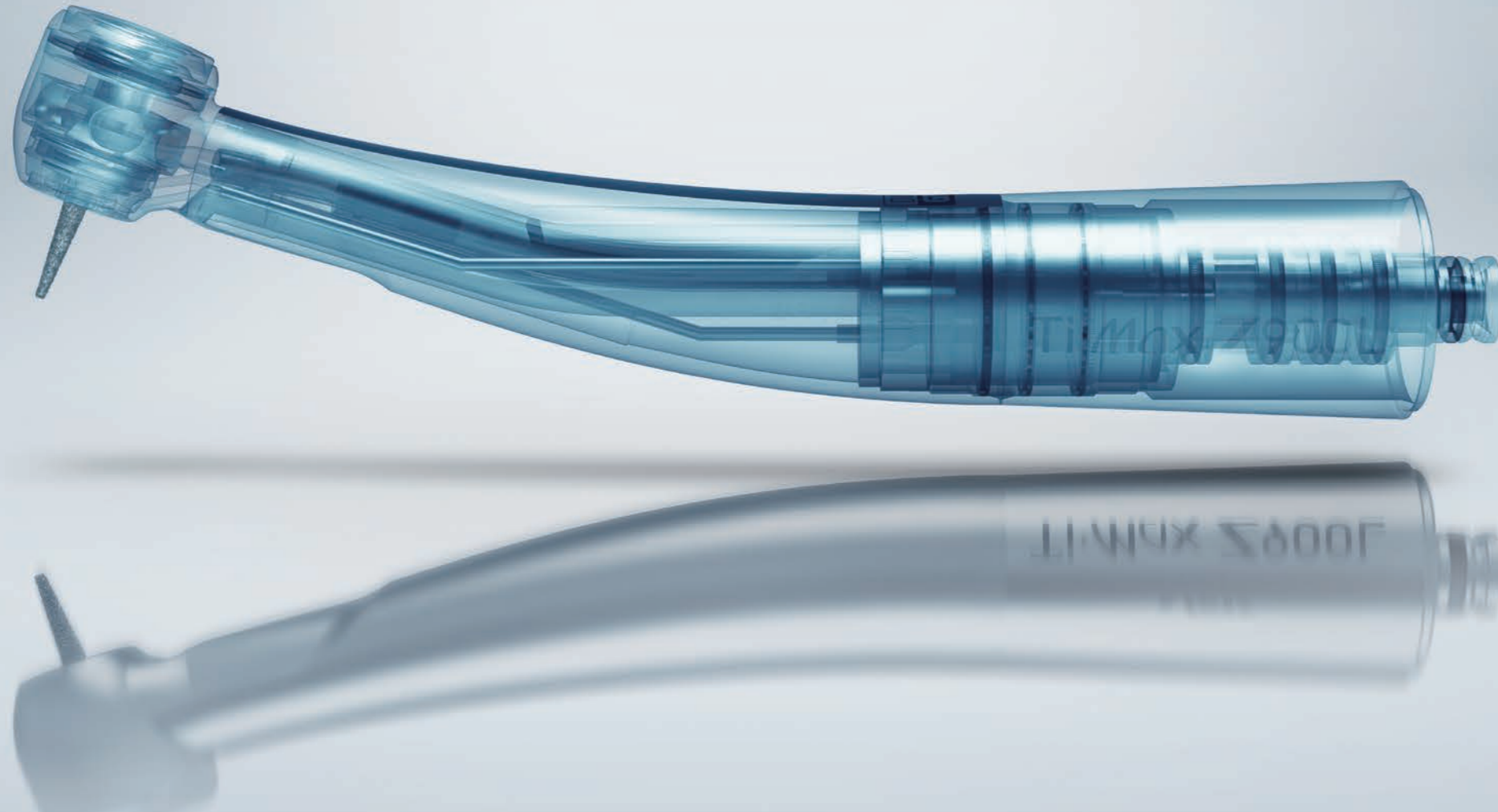

TECHNOLOGY & FUNCTION

Highly Accessible Head Angle

Slim Neck for Greater Visibility

Easy-Grip Body Shape

Compatible with
Other Couplings

New Three-Dimensional Rotor

New Bearings

Titanium Body

DURAGRIP

Push Button Chuck

Quattro Water Spray

Microfilter

Clean Head System

Air Turbine

POWERFUL

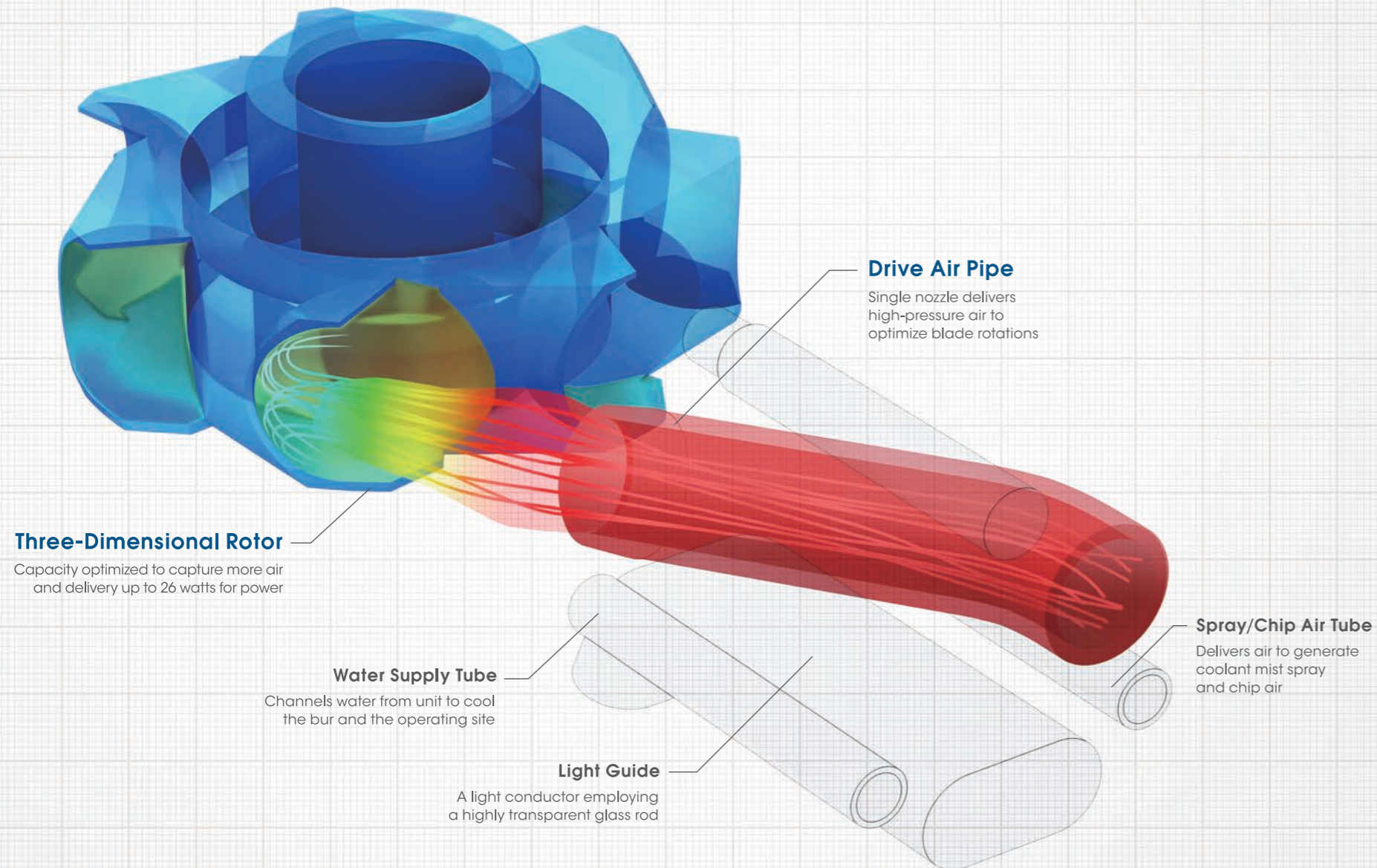

Miniature Parts for Maximum Power, Reflecting NSK's Pursuit of the Optimum Rotor Shape

New Three-Dimensional Rotor

We harnessed the latest computer analysis software to develop a rotor with higher output. We created a new three-dimensional curved shape after relentless simulations and pilot production. The blade is 50% larger than that of the Ti-Max X Air Turbine. With this new rotor, the air turbine delivers an amazing 26 watts* of power.

*With the Z900L

Blade surface 50% larger



Ti-Max Z Cartridge

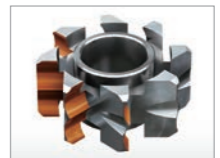

Ti-Max X Cartridge

High Output for Smoother Cutting

The 26 watts power output from the new rotor significantly enhances the performance during clinical applications. This can dramatically reduce treatment time and noticeably improve treatment comfort for the clinician and patient alike.

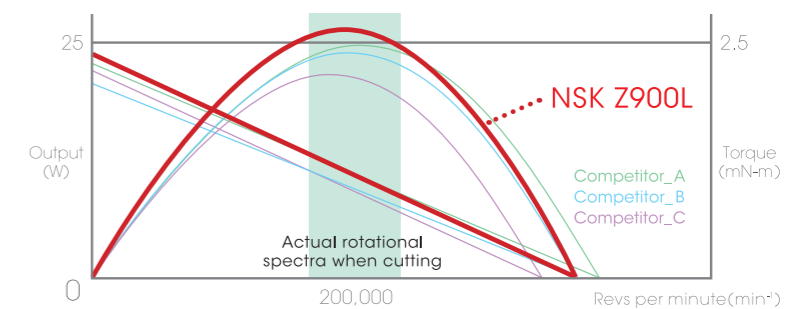

DURABILITY

Our powerful and durable air turbines maintain long-term comfort and stability

Outstanding durability and long-term operator and patient comfort are the result of NSK's technological advances in sophisticated design and precision machining. Our latest bearing design has doubled the life expectancy compared to conventional turbine bearings. Our extended warranty is testament to our confidence in our workmanship.

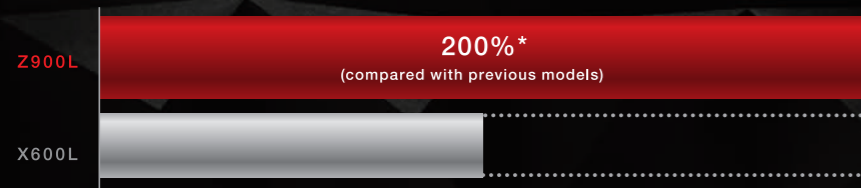

* Based on internal air turbine bearing durability test data

Durability Evaluation Test



Air Turbine

Ti-Max Z AIR TURBINE LINEUP

Standard Head



NSK Couplings

OPTIC MODEL : Z900L ORDER CODE : P1111

- Power : 26W ● Speed : 320,000-400,000 min⁻¹ ● Head size : φ12.5 × H13.1 mm ● Titanium Body & DURAGRIP
- Ceramic Bearing ● Push Button Chuck ● Quattro Water Spray ● Microfilter ● Clean Head System ● Cellular Glass Optics



KaVo® MULTIflex® Couplings

OPTIC MODEL : Z900KL ORDER CODE : P1113

- Power : 24W ● Speed : 320,000-400,000 min⁻¹ ● Head size : φ12.5 × H13.1 mm ● Titanium Body & DURAGRIP
- Ceramic Bearing ● Push Button Chuck ● Quattro Water Spray ● Microfilter ● Clean Head System ● Cellular Glass Optics



Lineup for Couplings of Other Manufacturers

We offer a wide range of models to fit couplings of different manufacturers to allow connections to various units.

Manufacturer	NSK	KaVo®	Sirona®	W&H® *	Bien-Air®
Model	Z900L	Z900KL	Z900SL	Z900WL **	Z900BL **
Order Code	P1111	P1113	P1115	P1121	P1117
Couplings					

KaVo® and MULTIflex® are registered trademarks of Kaltenbach & Voigt GmbH & Co.

Sirona® is a registered trademark of Sirona Dental Systems GmbH.

W&H® is a registered trademark of W&H Dentalwerk Bürmoos GmbH.

Bien-Air® and Unifix® are registered trademarks of Bien-Air Dental S.A.

*Also connectible with MORITA Custom Air®.

** Incorporates LED light in handpiece

Miniature Head

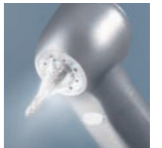

NSK Couplings

OPTIC MODEL : Z800L ORDER CODE : P1110

- Power : 23W ● Speed : 360,000-440,000 min⁻¹ ● Head size : φ10.8 × H12.1 mm ● Titanium Body & DURAGRIP
- Ceramic Bearing ● Push Button Chuck ● Quattro Water Spray ● Microfilter ● Clean Head System ● Cellular Glass Optics

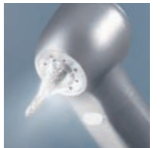

KaVo® MULTIflex® Couplings

OPTIC MODEL : Z800KL ORDER CODE : P1112

- Power : 21W ● Speed : 360,000-440,000 min⁻¹ ● Head size : φ10.8 × H12.1 mm ● Titanium Body & DURAGRIP
- Ceramic Bearing ● Push Button Chuck ● Quattro Water Spray ● Microfilter ● Clean Head System ● Cellular Glass Optics



Manufacturer	NSK	KaVo®	Sirona®	W&H® *	Bien-Air®
Model	Z800L	Z800KL	Z800SL	Z800WL **	Z800BL **
Order Code	P1110	P1112	P1114	P1120	P1116
Couplings					

NAKANISHI INC. www.nsk-inc.com

700 Shimohinata, Kanuma, Tochigi 322-8666, Japan

NSK Europe GmbH www.nsk-europe.de

Elly-Beinhorn-Strasse 8, 65760 Eschborn, Germany

Specifications are subject to change without notice.